

# **Seben Big Boss 1400-150**

Owner's Manual

Please read before using this equipment



**Deutsche Anleitungen finden Sie zum Download auf:**

<http://www.seben.com/manuals/>

**You can download instructions here:**

<http://www.seben.com/manuals/>

**Vous pouvez télécharger la notice en français sur:**

<http://www.seben.com/manuals/>

**Per il download delle istruzioni in italiano cliccate qui:**

<http://www.seben.com/manuals/>

**Puede descargar las instrucciones en español aquí:**

<http://www.seben.com/manuals/>

[www.SEBEN.com](http://www.SEBEN.com)

Seben GmbH – Ollenhauer Str. 73 -13403 Berlin – Deutschland

## Interesting information for starting

By buying a telescope you made the decision to pursue a very interesting and exciting hobby and we congratulate you. We would like to give you a couple of tips upfront.

### **Astronomy isn't a cinema movie**

Astronomy isn't a cinema movie that you watch for a couple of hours without doing anything. This great hobby needs a lot of self-initiative and a high self-motivation. Take your time for this beautiful hobby, because, like with many other things, you have to practice the handling of a telescope, how to properly view things with it and the orientation. The pictures that you'll see are also not the ones that you've seen as colored pictures from NASA or that you know from the media. So don't be disappointed when you'll get to see how an object really looks like through your own telescope.

Don't expect too much at once and approach the topic slowly. You'll only see as much as your experience and your ability allow you to see, even with the best and most expensive telescope. The journey is the destination and the fascinating thing about this hobby is the independent discovery of the objects and the analysis of time and space.

### **Learning from others**

The exchange with other astronomers is an important factor and nowadays this can be easily done through the many Internet forums. By talking with like-minded people you can get tips and solve many problems and answer many questions yourself. Maybe you're also looking for an astronomy club near you?

There are countless objects in the sky that can be seen with a telescope. A map of the stars is essential, so that you're able to orientate and find specific objects. You can find and purchase one that is robust and made of plastic on the Internet.

It's essential to buy an astronomy book that's suitable for you and we recommend that you don't eschew this purchase. Our experiences have shown that hobby astronomers get better observation results and also derive a lot of joy from this hobby by using a book.

Children should watch together with someone else, who is already experienced with a telescope, if possible.

### **Not every location is suitable for observing**

It's best to look for a spot that is as dark as possible. You're lucky if you live outside of the city. The ones living in the city should drive outside of it to get better observation conditions. Because it's almost impossible to find a dark observation location in the city, due to the many light sources.

Consider that the temperature of the telescope has to adapt to the outside temperature to get decent observation results.

### **The underground is also determining the observation quality**

Avoid pulling out the tripod legs completely and erecting the tripod when it's very windy, so that you have a proper footing. The flatter the instrument is standing the more stable it is.

Make sure that the tripod is standing on a firm ground. Balconies, wooden floors or other undergrounds can make observations more difficult, due to their high self-oscillation.

### **Free sight for your telescope**

Don't observe through a window or through an open balcony door, because the temperature differences between inside and outside and/or the thick window glass are making it impossible to get a sharp picture.

## How does a telescope actually work?

A telescope collects the weak light of the stars better than a human eye is able to. Thus you can see more in the sky with it.

Depending on the kind of objective you distinguish between refracting telescope and reflecting telescope. Both have the same job; to capture the light of a distant object and accumulate it at the focal point, where the ocular will then magnify the image. All telescopes create an image that is turned by a 180 degree angle; so it's upside down and mirror-inverted

### **Telescope designs**

#### The refracting telescope:

You look into a refracting telescope at the rear end. They are also called refractors, because they break the light (Latin "fractere"=breaking). The light falls from the frontal lens onto a second lens and from there through an "ocular" into the eye.

The reflecting telescope:

You look into a reflecting telescope at the side. Reflecting telescopes are also called “reflectors”, because they reflect the light (Latin “reflectare”=reflecting). The light falls through the frontal opening onto the big main mirror. It reflects the light onto the small secondary mirror, which is located in the tube called “lens barrel”. From there the light falls through the “ocular” into the eye.

**Optics**

Magnification

The size of a telescope is determined by the opening and the focal length. The opening is the diameter of the objective lens or the main mirror and the focal length is the distance of the objective lens or the main mirror to the focal point. The magnification can be change as desired through oculars with different focal lengths. Here an example:

Telescope Seben 1000/114 > opening 114mm, focal length 1000 > magnification with a 10mm ocular  $1000/10 = 100x$

Light-gathering power

The light-gathering power is dependent on the diameter of the objective or the lens of the telescope. Simply put: the bigger the diameter, the higher the light-gathering power. It increased squared with the diameter.

The light-gathering power of the telescope is calculated like this:  $\text{Opening}^2 \text{ in mm}^2 / 49$

Example: Opening 114mm > light-gathering power 265 (calculation:  $114^2 / 49 = 265$ )

Resolution

The resolution capability increases linearly with the size of the optical diameter and it makes it possible to see things more detailed. The resolution capability is calculated like this:  $138 / \text{opening in mm}$

Example: Opening 114mm >  $138 / 114 = 1,2''$

**Accessories for telescopes**

**Please note that this is a general information and that the mentioned accessories are not included in the delivery of the telescope that you bought.**

**The ocular**



A telescope is a tube with lenses or mirrors inside. It collects the light and sends it out again through an opening. The opening is also called “focuser”. If you look into the opening without an ocular then you won’t see a sharp image. It’s the ocular that collects and magnifies the light as a lens onto a point of the retina in the eye. There is usually a number on the oculars. The higher the number the less it magnifies the section of the image.

The ocular is put into the focuser. When you change the ocular you’ll see that the picture won’t be sharp anymore with the new ocular. Every ocular has a different “focal point”, so it collects the light on a different point than the last ocular. So it’s best to adjust the image and make it sharp again with every change of the ocular. Use the wheels on the side to move the focuser in and out. Always start with the smallest magnification. Take your time when you observe. You have to learn first how to observe with a telescope.

**The diagonal (only for refractors)**



The picture is upside down and inverted in astronomical telescopes. The star diagonal is righting the picture again, so that you can also comfortably make nature observations, but it doesn’t correct the inverted image. It deflects the optical path by 90 degrees, so that it’s easier to observe objects near the zenith through the ocular.



The Amici prism corrects both, so it rights the picture again by 180 degrees. Amici prisms are available with a 90 degree and 45 degree deflection. Prisms are put into the focuser before the ocular.

**Prisms are only used in refractors.**

**The reversing lens (mainly in reflectors)**



The picture is inverted in an astronomical telescope and upside down. This isn't important for an astronomical observation, but it is for a terrestrial observation. The reversing lenses make sure that the image is upright, but not laterally correct in a terrestrial observation. The reversing lens for telescopes is intended for occasional usage, because telescopes are only partly suited for terrestrial observations. **Reversing lenses are used with reflectors.**

**The Barlow lens**

You can use special lenses like the Barlow lens to increase the focal length. The Barlow lens increases the focal length and thus the magnification of a telescope. It has rating that shows how high the increase of the focal length is. It's written on the Barlow lens and usually is 2x, but also 1.5x or 3x.

If you combine a 2x Barlow lens, for example, with a 60/900mm telescope, then the resulting focal length is 1800mm. If you now put a 20mm-ocular into the Barlow lens, then the magnification increases from 45x to 90x.



**The moonfilter**

The moon filter reduces the brightness of the moon and increases the observation contrast. This way you can see the finer details of the moon surface, which would otherwise get lost due to overexposure.



**The color filters**

The color filters are made to increase the contrast when observing planets, so that you can see the details of the surfaces that are hardly recognizable. Seben also offers an astronomy filter package as accessory, which offers you the most important color filters in one package. A reasonable addition, so that you can have an even better observation.



**Sun filters**

Please note that the sun can't ever be observed without the use of suitable filters. The person who doesn't adhere to this guideline will be punished by immediate non-reversible blindness. So be very careful and thorough when observing the sun. Sun filters that are attached to the ocular are highly dangerous. They can suddenly break due to the heat of the sun and expose the eye of the observer directly to the sun. This will lead to an immediate and non-reversible blindness.

There are high quality sun filter foils in accessory shop that are being put in front of the telescope opening, if you're interested in observing the sun You have to always adhere to the warning messages of the manufacturer when observing the sun!

**The finder**

Many objects in the sky can't be seen with the naked eye, so you need help to find them. A "finder" or the "finderscope", a small refractor with an ocular that has a low magnification and a large field of vision, is used for that purpose. If it's aligned parallel to the telescope, then you can easily look for an object through the finder and then admire it through the telescope.



### Our most popular accessories



#### Smartphone adapter Seben DKA5

The DKA5 is a smartphone mount for your telescope and ideal for making pictures and videos with your smartphone in combination with the telescope. The DKA5 is simply connected to the ocular of the telescope through a stable clamping device. The smartphone is also connected with the DKA5 this easily.



#### Seben 31,7mm 1,25" Zoom 8-24mm FMC Telescope Ocular

Since 2004, the Seben Zoom 8-24mm FMC Ocular is the most sold Seben ocular of all times and is being used a thousand times by astronomers around the world with the greatest satisfaction.

Countless test reports, comparison tests and hundreds of statements in astronomy forums and blogs about our Seben Zoom 8-24mm FMC Ocular clearly show: The original Seben Zoom 8-24mm FMC Ocular in this FMC production quality and processing can only be found here.

Perfect to cheaply cover many focal lengths with only one ocular. It's also ideal for putting together a space-saving equipment for travels or for mobile observations.

If you own a beginner telescope with simple standard oculars and if you want to have more fun with astronomy in a cheap way, then you'll experience an incredible increase in performance when you're using the Seben Zoom 8-24mm FMC Ocular.



#### The paralactic mount

Both axes are aligned to the axis of the earth, whereby one axis is adjusting the right ascension and the other axis the declination. For tracing you now only need to adjust the right ascension.

The right ascension axis is set to the celestial pole, also called polar star, whereas the declination axis points to the celestial equator.

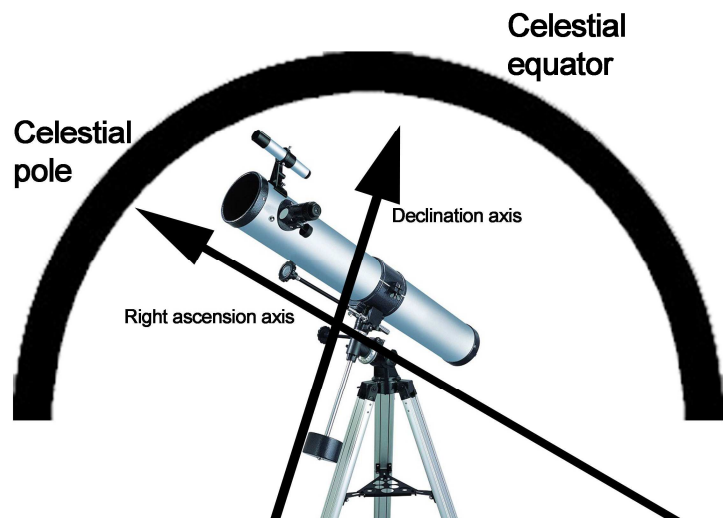

Handling this kind of mounting has to be learned, because it's set up to follow the apparent celestial movements.

This kind of mounting is very good for DeepSky observations or also for astrophotography, because the paralactic mounting follows the movement of the stars (see above).

### Setting up the telescope

Put the package on a save underground and open it carefully.  
Get ALL boxes out of the package, because they are also on one another. Empty boxes are merely there to ensure the transportation.

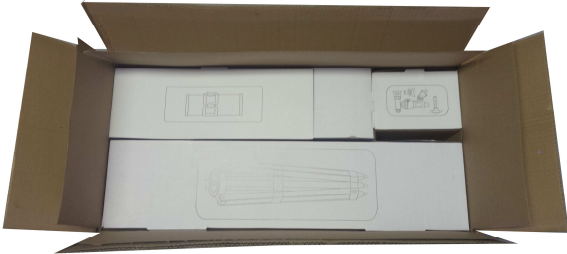

Put all components on a save and flat underground, so that you can see them properly. Be careful to not damage the lens barrel and to not lose the small screws.



For the erection of the tripod we need the following parts:  
3 tripod legs, tripod mount, ocular shell, 3 screws with female screw, 3 screws with butterfly nut, maybe 3 screws to fixate the tripod (if they aren't already there).



At the tripod mount there are three mountings. Take one tripod leg and slide the upper connecting piece carefully to the mounting of the tripod mount. Ensure that the holes for the screws are at the same spot. You can simply take a look from the side to see if the holes are aligned fittingly. Also especially ensure when setting up the tripod leg that the mounting for the ocular shell is on the inside!



Remove a butterfly nut from one of the three screws and put the screw through the hole, so that the connection of the tripod and the mounting of the tripod mount is fixated.



Now the first leg is mounted and it should look like on the picture here. The tripod leg and the tripod mount are firmly connected and the mounting for the ocular shell is pointing inwards. Repeat these steps for the mounting of the tripod leg and mount the second and third leg the same way.

All mountings for the ocular shell point inwards.

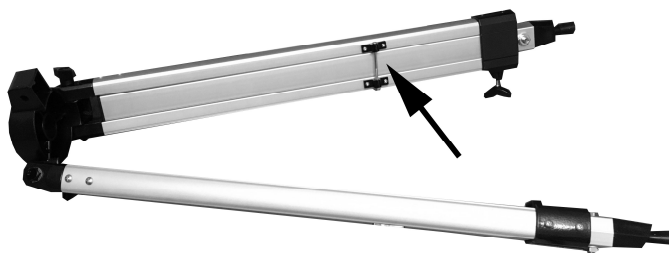

If the 3 screw to fixate the tripod legs aren't attached already, then please screws them into the tripod legs.

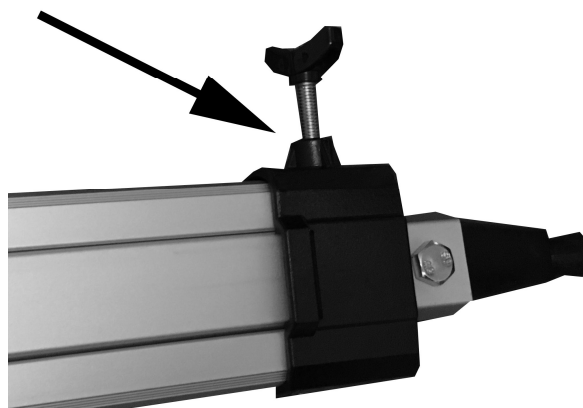

1  
Now you need the holder for the ocular shell and the three small screws with the female screws.

2  
Spread the legs of the holder for the ocular shell, so that they're straight.



Slide the end of one of the legs of the holder for the ocular shell into a mounting on the tripod leg. Ensure that the opening of the holder points with the thread upwards. Remove the female screw from the screw and put the screw through the hole. Then screw the female screw in from the other side.

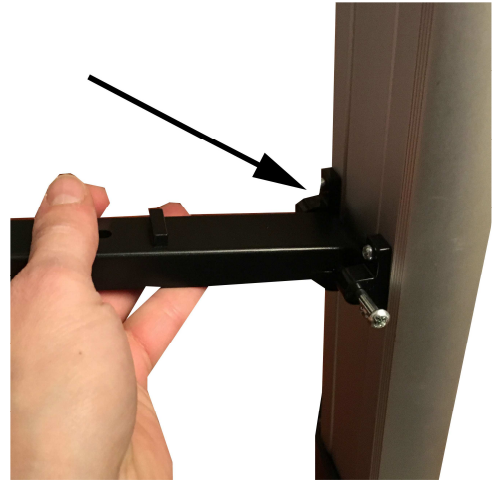

Repeat this procedure with the two remaining holders of the holder for the ocular shell.



Now you can tighten the ocular shell. Turn the ocular shell to the right until it's fixated. Be careful to not overtighten the thread.



You have now successfully assembled the tripod. Set the tripod on a stable and plane surface so that it stands horizontally. To ensure maximum stability, the tripod legs should be maximum spread, but not completely pulled out.





## Setting up the telescope

The mounting is set-up absolutely horizontal. A water level is very helpful in this case. Put the mounting on the tripod mount and screw it together from below



Rotate the declination axis of the mounting upwards, if needed, and attach the telescope tube ring. You need the rail for the telescope tube rings.



Place the rail up, insert the screws through the two holes and tighten them.



Now attach the telescope tube rings correctly.  
Put the screws back in, through the holes in the telescope tube rings and tighten them.

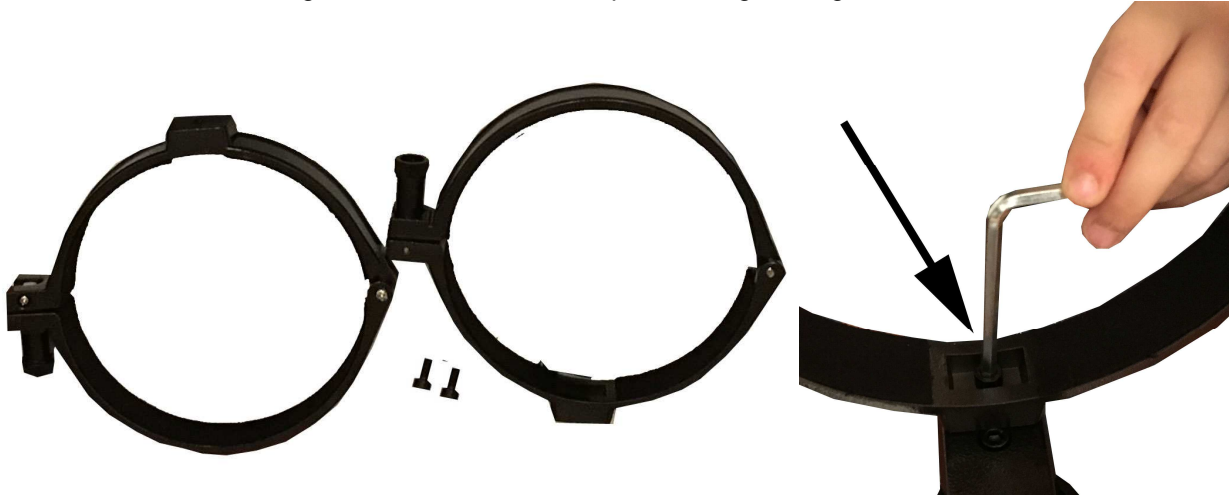

Attach the fine movements shafts.  
To do that, remove the small protective rubber studs from the locating bolts, if necessary.

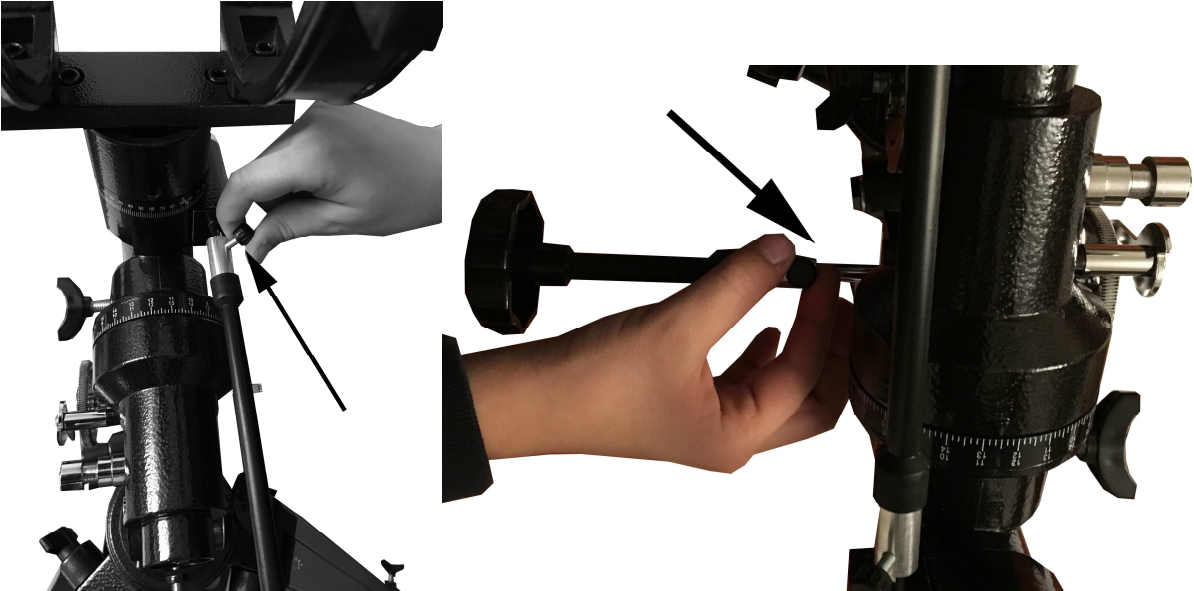

Take the weight and slide it onto the weight rod. Screw the rod correctly into the mounting from below.



Put the tube into the telescope tube rings and close the telescope tube ring at the side. Make sure that the declination shaft is pointing towards the ocular.



Loosen and remove the screw heads on the front tube and put the viewfinder on the screws. Then screw the heads back on the screws so that the viewfinder is firmly on the tube. Make sure that the narrow end points towards the focuser. This is the opening to look into.

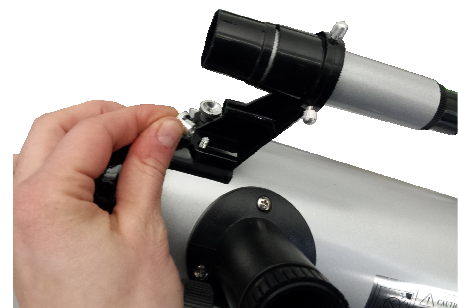

Screw the locking screw onto the altitude adjustment.

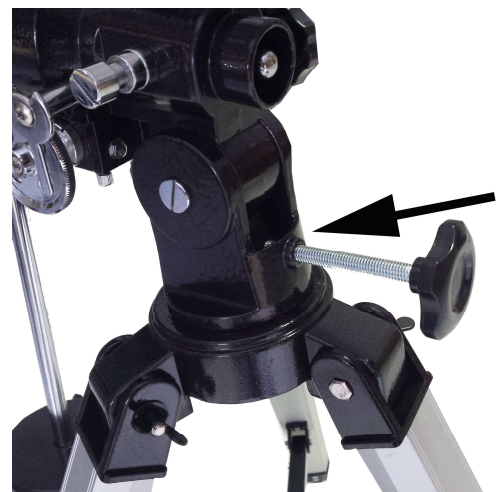

## Adjustment of a paralactic mounting

Every paralactic mounting has two axes, which each can be opened, moved and closed again. These are the right ascension axis and the declination axis.

If you've adjusted and aligned the telescope correctly, then the advantage of this paralactic mounting is that you now can only track the celestial objects through the fine movement with the shafts.

**You can control the movement automatically through an additionally attached motor (available in Seben's accessories program).**

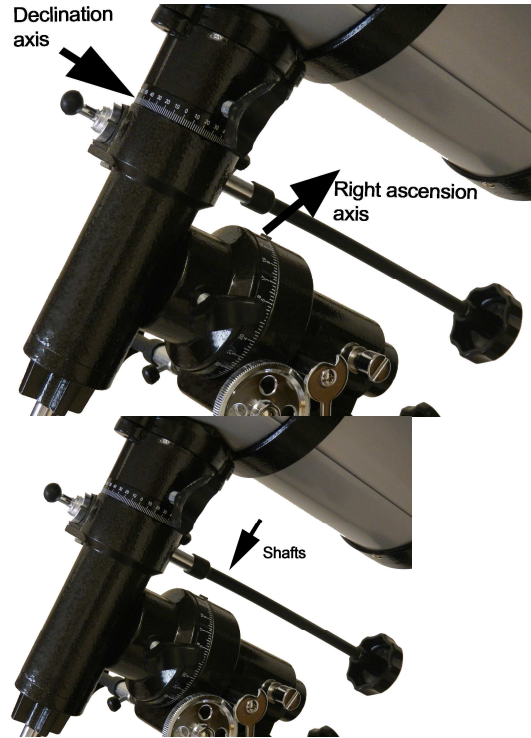

The adjustment of the mounting is important, because both axes have to stand level. This has the effect that the telescope, no matter how it's positioned, won't tip over sideways due to the unilateral overload. Think of a seesaw: if one side has more load on it, then it will sink downwards.

On the one hand this affects the tube, which has to be level in its telescope tube ring: it shouldn't tip over sideways when the axis is opened.

On the other hand it affects the axis of the tube and the weights. Also here, if the axis is opened, then neither the tube nor the counterweight should drift off.

If now both sides have the same weight, like with a seesaw, then they are in balance and adjusted.

We'll now explain you how to do that in detail.

We first adjust the right ascension axis. This axis affects the tube and the rod with the weights.

First bring the telescope tube and the counterweight in a horizontal position. Now you can see if a side is heavier than the other and if it slumps downwards.



Loosen the right ascension clamp. It holds the axis. If you loosen this clamp, then the axis is freestanding and can be moved like a seesaw.

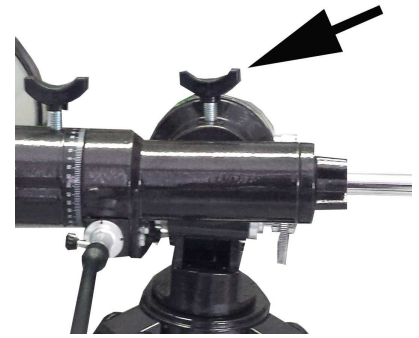

The side of the telescope tube or the side of the counterweight will now probably sink downwards. It depends on which side is heavier.



Depending on if the tube or the counterweight sinks down, move the counterweight on the rod to achieve a balance.

If you achieved that, then secure the counterweight and close the right ascension clamp.

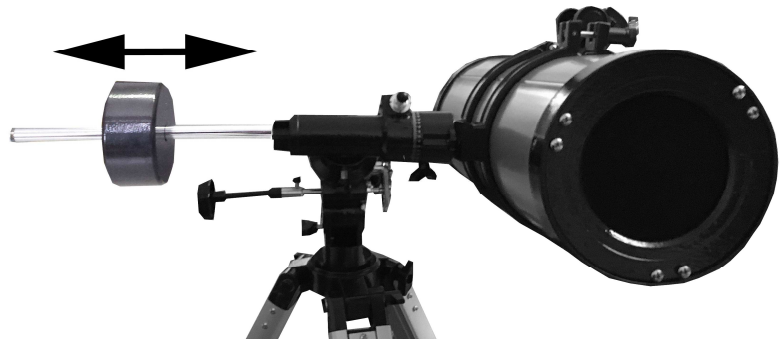

You've now adjusted the right ascension axis. That means that this axis will now always be level, independent from the position the telescope is in.

Now we just have to balance the second axis. This affects the tube. We need the declination clamp to do this. It ensures that the tube won't move and is locked or in other words, that the tube can be moved if it's open.

So now open the declination clamp. The tube is now freestanding and you'll see that it perhaps has excess weight on one side and slumps down. The same principle as with a seesaw applies here.



To correct that, slightly open the clasp of the telescope tube ring, so that the tube can be moved back and forth. Move the tube until it doesn't move anymore by itself (meaning it won't slump down on one side) and then close the declination clamp again.



You have now successfully assembled the tripod.



### First observations

Set up the telescope outside at least half an hour before the beginning of observation so that it can cool down.

Please take the lid from your telescope and remove the cap from the eyepiece.



### Insert eyepiece on reflectors

Before you focus on your first goal, put an eyepiece with a magnification as small as possible, thus with a large number (for example, 20mm), in the focuser.

Now take out the eyepiece of the protection container and put it in the focuser. Then tighten the side screw on the focuser so that the eyepiece can no longer move.



### Aligning the finderscope

Check whether the telescope and the viewfinder have been set correctly. The finder scope must be precisely adjusted in parallel to the main telescope. Pick a distant object, such as a tower or a light spot.



Put an eyepiece with the smallest possible enlargement, ie with a large number (for example, 20mm), in the focuser. The sharpness can be set on the side with the wheels.



Look through the telescope and place it on position on the top of the tower.

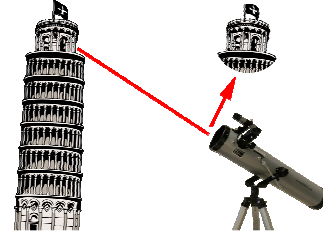

Look through the viewfinder tube. If you do not see exactly the same image, adjust the viewfinder tube. On the search tube you will find small screws, which can be used to adjust the viewfinder tube until the object can be seen exactly in the viewfinder tube. Then you have aligned telescope and finder telescope parallel to each other. If you encounter the viewfinder, repeat the procedure.

The viewfinder should be set up before each observation.



### Aligning the telescope with a paralactic mounting

Important information: We're trying here to explain to you the alignment of a paralactic mounting as easily and descriptively as possible. But you should still bear in mind that difficulties can arise, despite the instructions. So please don't be afraid to look for any additional help. Construction videos on the Internet are very helpful here, like the ones you can find on Youtube.

You have to align the telescope so that you can find the celestial objects later. Please remember that the mounting, therefore the tube and the opening, points northwards. You can use a compass here.

First align the right ascension axis (polar axis), with the help of a compass, northwards. That means that the telescope tube, with it's opening, points towards the polar star.

Now look through the finderscope and aim at the polar star. The polar star should be visible in the middle of the visual field of the finderscope.

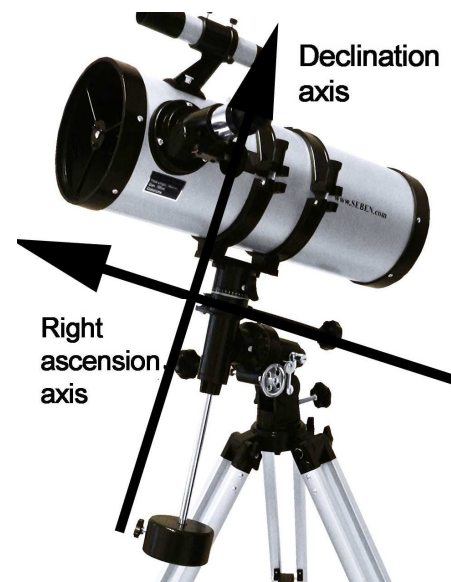

Now adjust the correct latitude.

You can adjust the latitude with the altitude adjustment T-bolt on the lateral latitude scale. You can find out the exact latitude of your location on the Internet.

The latitude in Germany is usually about 50 degrees. You're adjusting the latitude by turning the altitude adjustment T-bolt. The telescope tube will then tilt in this angle.

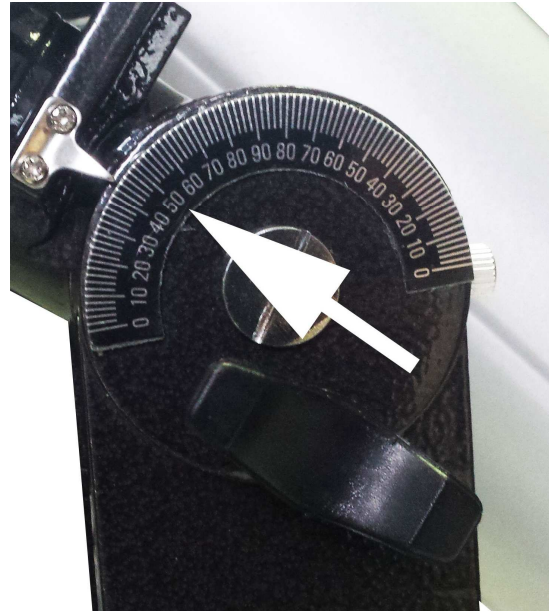

You can now trace the movement of the stars, if you found a celestial object, through the tracking of this right ascension axis. We want to explain this to you briefly: The celestial objects seem to move in a circular path, because the earth rotates. If we don't move the telescope and just keep looking at one point, then the celestial object will be soon out of your visual field.

But if you've adjusted and aligned the telescope correctly, then only the fine adjustment with the shafts is necessary, so that you can observe the object, without it disappearing from your visual field.

#### How to use the moon filter?

The moon filter can be screwed by means of its socket in the socket of the eyepieces. The moon filter and the eyepiece, you can then use as usual in the focuser. If you replace the eyepiece, you should also screw the filter out and back in.

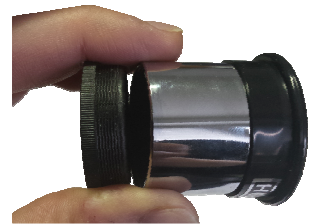

#### How to use a color filter?

Like the moon filter, the single color filter is screwed into the eyepiece and then inserted into the eyepiece output with the eyepiece.



#### How to use reversing lens and barrio lens?

First place them in the eyepiece and then insert it into the eyepiece.





## What to look for in the sky:

### The moon

The moon is the easiest target to find in the night. When it is in the full position, when the entire face is lit, then it bathes the night with a silvery light washing out the rest of the sky from all but the brightest objects. The best time to view the moon is actually not when it is full by rather anytime up to the first quarter, this is when the face appears to be half lit up.

The terminator on the moon, the dividing line between dark and light, shows the best features such as craters and mountains.

### The planets

The planets are our solar system companions. These range in size from moon size rocky bodies to giant gas balls which could hold 1000 earths. To find the planets requires some information as to when they are visible. An astronomy magazine such as SkyNews or Sky and Telescope will give you the locations of the planets from month to month. Most people who have looked up at night have probably seen some planets but did not realize it. A planet, when it is well clear of the horizon will not twinkle as do the stars. They are resolved by the eye as tiny balls as opposes to the stars which are infinitely small points of light. The easiest planets to view are Venus, Mars, Jupiter and Saturn, Uranus and Neptune. Mercury is an object to look for but it is usually below the horizon and often is a challenge to find. Pluto is too small for most telescopes below 10" so do not worry about finding it at this time.

Each of the planets has its own interesting views. Venus is covered with clouds. So all we see is an extremely bright light, the brightest next to the moon. However it goes through phases like our moon. In other words the planets surface will, as it travels around the sun, appear to have different amounts of it lit up. This gives the planet varying crescent shapes, as if a bite were taken out of it.

Beyond our solar system there lies a multitude of objects to be found. Galaxies, nebulae and star clusters abound.

## What you can discover on the night sky

### Finding objects in the sky

You need a lot of time to look for and find objects in the sky, especially when you're using a telescope for the first time. But consider that you have to first learn to orientate and this is easier in the beginning with simple and bright objects. The disappointment here isn't big as well, because astronomical objects don't look like we know them from books or the Internet, except for the moon.

### Looking for bright sky objects

Try to see the moon first. Search for the moon in the finder, to observe it. When it's in the middle there, then it should also be in the middle in the ocular as well. Now look through the ocular and turn the wheels of the focuser until the image is sharp. You'll find countless craters, partially with small central mountains in the middle. It's important that the finder is first adjusted in parallel to the telescopic tube.

### Star hopping

The first observations can be very irritating, because the picture in the telescope is upside down and inverted and the picture of the map of the stars looks different. This effect can be reversed with a reversing lens when doing terrestrial observations, but if you're doing sky observations then you shouldn't use it, because the combination of lenses is impeding the light-gathering power of the telescope. You'll get used to the unfamiliar view with a little bit of practice and patience and you'll orient yourself better.

If you're starting with the search for objects then you should first select points from constellations which you can see the whole year. One example would be the Great Bear. In the beginning just watch the sky with the naked eye and find the constellation, a map of the stars is helpful here.

Then if you found the constellation, search for the confining main stars. Now you can target one of these stars. Take your time and be patient to successfully master this; even many tries are not unusual even for experienced astronomers. Be careful to not zoom too much, because the movements will be getting larger and it blurs very quickly.

### Focus

Many beginners oftentimes have the problem that the targeted object can only be seen blurred. In a telescope the gathered light rays are focused through mirrors and/or lenses to the outside into the eye, so that we can see something, for example the moon. You can use the wheels on the focuser to turn it in or out, whereby you adjust the focal point of these concentrated light rays. If you change the ocular then you have to readjust the focus. Please note that the higher the magnification is, the harder it is to adjust the focus.

## Care and cleaning of Optics:

### **WARNING: Improper cleaning of optical components may void the warranty!**

Optical components of a telescope will over time get dirty. The amount of dirt and or dust collected onto a lens or mirror should only be removed with the utmost care and this is at times best left to people with experience in this procedure. A considerable amount of dirt or dust must be present on the optical surface before one will notice the effect visually.

1. Keeping the dust caps during storage of the telescope will reduce the amount of dust collected.
2. After using the telescope there might be dew condensation on the optical surfaces. When the telescope is brought inside remove the dust caps and allow the moisture to evaporate naturally. Point the telescope downwards so as to minimize the collection of airborne dust.
3. Once the moisture is gone then replace the dust caps.
4. If you wish to remove dust from the lenses or mirrors you first should try using a can of filtered compressed air. Remove the dust cap and the dew shield in the case of the refractor style of telescope, or take the mirror cell out of the reflecting type. Once you are able to freely blow across the surface of the optics then begin by first pointing the can away from the piece and gently expel some air. This will remove any condensate in the air can lines and clear off dust that may have accumulated on the discharge tube. Next using short quick bursts of air carefully remove the dust particles.

**DO NOT HOLD THE TRIGGER OF THE COMPRESSED AIR FOR TOO LONG AS CONDENSATE MIGHT BE BLOWN OUT ACROSS THE OPTICAL SURFACE.**

The optics of your telescope should last a long time before they generally require major cleaning. By keeping the dust caps on and avoiding the temptation to handle the lenses or mirrors you will find that very little is needed in the way of optical maintenance.

### **Common problems with telescopes**

- Did you remove the lid and put an ocular in? Did you not only remove the small, but also the big lid completely? With the lid on and without the ocular, too little light gets into the telescope and all you see is black. Remove the lid and put the ocular in.
- Did you adjust the finder in parallel to the telescope? If this isn't the case, then you might target an object with the finder, but you won't see it through the telescope. Adjust the finder.
- Did you start with a magnification that is too high? This can be the reason for a black image. It's best to start with a small magnification, adjust the image so that it's sharp and then slowly increase the magnification. You're making the image sharp by moving the focuser in or out through the wheels on the side.
- Didn't you make the object sharp enough through the focuser? You're making the image sharp by moving the focuser in or out through the wheels on the side.
- Is the telescope adjusted? The mirrors can move, because of the transport. If they're too much out of alignment, then the telescope will show a worse image on higher magnifications. A laser collimator can help in this case to adjust the telescope.
- Did you let the telescope cool down enough outside? Otherwise the instrument can't display an image properly.